

02/2016

# Mod: BT15

Production code: 8035011



**SCHEMA DI INSTALLAZIONE- INSTALLATION DIAGRAM - INSTALLATIONSSCHEMA - SCHEMA  
D'INSTALLATION  
ELEMENTI BAGNOMARIA - BAIN-MARIE UNITS - BAINMARIE-ELEMENTE - ELEMENTS BAIN-MARIE**

**Mod. : BT 8 (8035009)**

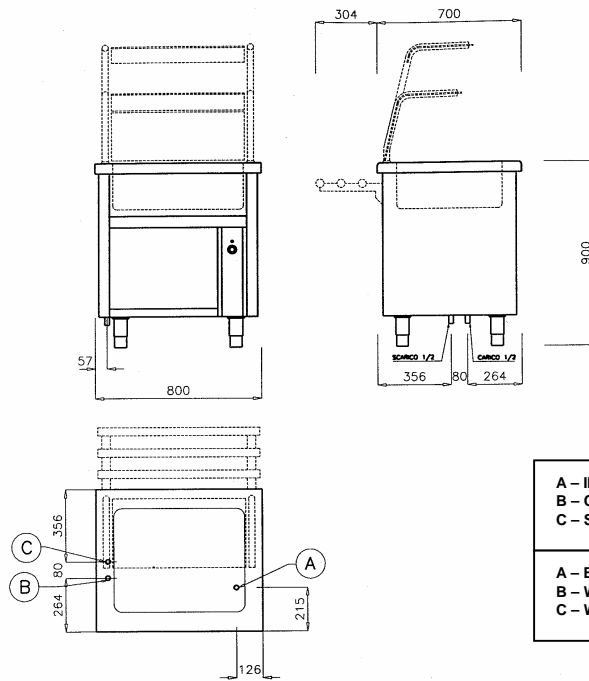

A - INGRESSO CAVO ELETTRICO B - CARICO ACQUA 1/2" C - SCARICO ACQUA 1/2"	A - ELEKTROANSCHLUSS B - EINLAUF WASSER 1/2" C - WASSERABFLUSS 1/2"
A - ELECTRIC CONNECTION B - WATER INLET 1/2" C - WASTE WATER OUTLET 1/2"	A - CABLE D'ALIMENTATION B - ENTREE EAU 1/2" C - EVACUATION EAU 1/2"

**Mod. : BT 12 (8035010)**

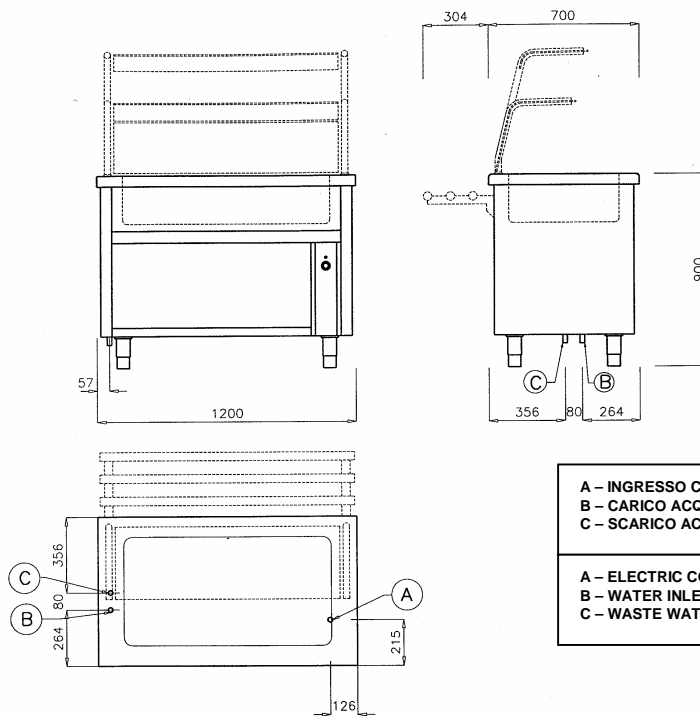

A - INGRESSO CAVO ELETTRICO B - CARICO ACQUA 1/2" C - SCARICO ACQUA 1/2"	A - ELEKTROANSCHLUSS B - EINLAUF WASSER 1/2" C - WASSERABFLUSS 1/2"
A - ELECTRIC CONNECTION B - WATER INLET 1/2" C - WASTE WATER OUTLET 1/2"	A - CABLE D'ALIMENTATION B - ENTREE EAU 1/2" C - EVACUATION EAU 1/2"

**Mod. : BT 15 (8035011)**

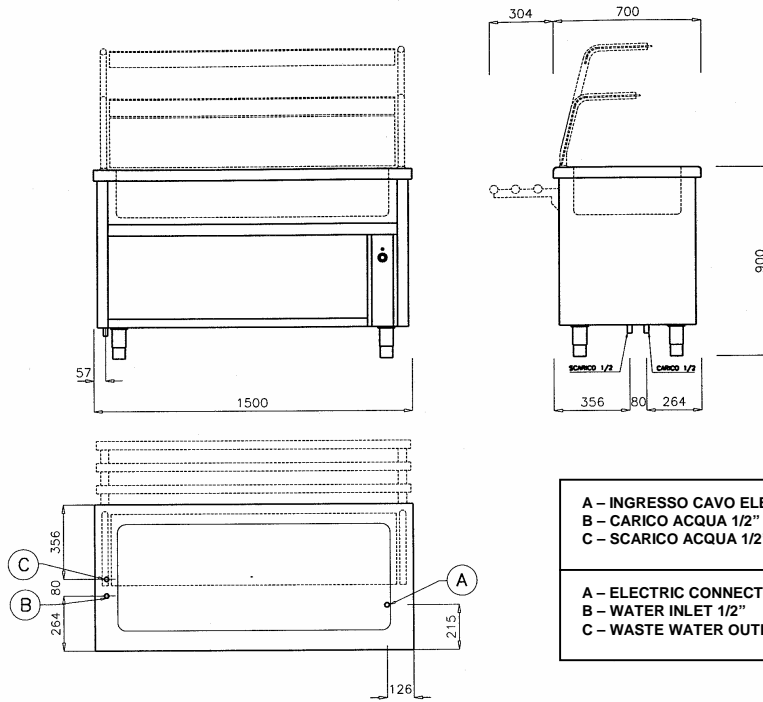

**Mod. : BT 23 (8035057)**

