

11/2019

Mod: DH53/T2V

Production code: TS44D

Fig. 1

TS5; TS8

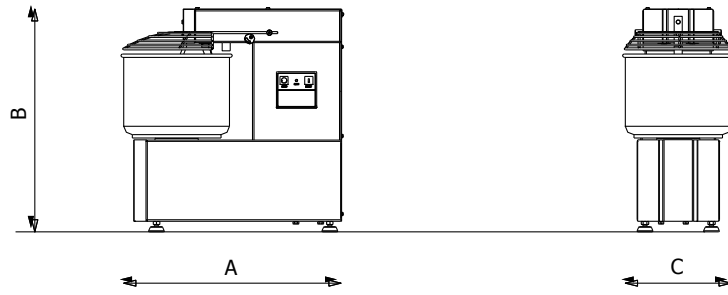

TS12; TS18; TS25; TS38; TS44

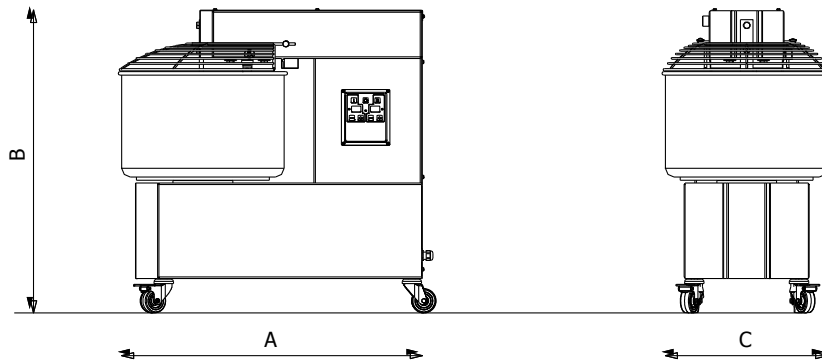

TSA12; TSA18; TSA25;
TSA38; TSA44

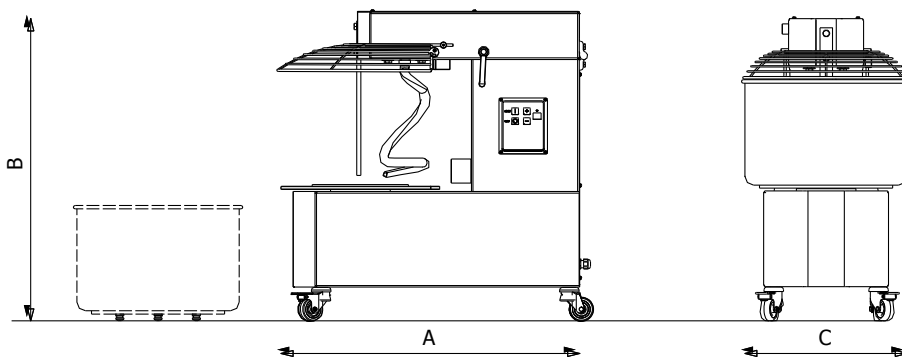

1.3 TECHNICAL SPECIFICATIONS

	Model	Kneading capacity	Flour capacity	Bowl volume	Bowl dim.	Motor Power	Volt	Dimensions mm	Weight Kg
FIXED HEAD AND FIXED STEEL BOWL	TS5M	5	3	7	237X160	0.37	230/50/1	540X260X520	38
	TS5T	5	3	7	237X160	0.37	400/50/3	540X260X520	38
	TS5D	5	3	7	237X160	0.3/0.45	400/50/3	540X260X520	38
	TS8M	8	5	10	260X200	0.37	230/50/1	550X270X553	40
	TS8T	8	5	10	260X200	0.37	400/50/3	550X270X553	40
	TS8D	8	5	10	260X200	0.3/0.45	400/50/3	550X270X553	40
	TS12M	12	8	15	317X210	0.9	230/50/1	690X335X630	68
	TS12T	12	8	15	317X210	0.75	400/50/3	690X335X630	68
	TS12D	12	8	15	317X210	0.6/0.8	400/50/3	690X335X630	68
	TS18M	18	12	20	360X210	0.9	230/50/1	715X380X630	70
	TS18T	18	12	20	360X210	0.75	400/50/3	715X380X630	70
	TS18D	18	12	20	360X210	0.6/0.8	400/50/3	715X380X630	70
	TS25M	25	17	33	400X260	1.1	230/50/1	785X420X700	85
	TS25T	25	17	33	400X260	1.1	400/50/3	785X420X700	85
	TS25D	25	17	33	400X260	1/1.4	400/50/3	785X420X700	85
	TS38M	38	25	40	452X260	1.5	230/50/1	830X470X770	97
	TS38T	38	25	40	452X260	1.5	400/50/3	830X470X770	97
	TS38D	38	25	40	452X260	1.5/2.2	400/50/3	830X470X770	97
TS44M	44	30	50	500X270	1.5	230/50/3	870X520X770	102	
TS44T	44	30	50	500X270	1.5	400/50/3	870X520X770	102	
TS44D	44	30	50	500X270	1.5/2.2	400/50/3	870X520X770	102	

	Model	Kneading capacity	Flour capacity	Bowl volume	Bowl dim.	Motor Power	Volt	Dimensions mm	Weight Kg
LIFTABLE HEAD AND EXTRACTIBLE STEEL	TS12A	12	8	15	317X210	0.9	230/50/1	690X335X630	79
	TS12A	12	8	15	317X210	0.75	400/50/3	690X335X630	79
	TS12A	12	8	15	317X210	0.6/0.8	400/50/3	690X335X630	79
	TS18A	18	12	20	360X210	0.9	230/50/1	715X380X630	82
	TS18A	18	12	20	360X210	0.75	400/50/3	715X380X630	82
	TS18A	18	12	20	360X210	0.6/0.8	400/50/3	715X380X630	82
	TS25A	25	17	33	400X260	1.1	230/50/1	785X420X700	98
	TS25A	25	17	33	400X260	1.1	400/50/3	785X420X700	98
	TS25A	25	17	33	400X260	1/1.4	400/50/3	785X420X700	98
	TS38A	38	25	40	452X260	1.5	230/50/1	830X470X770	112
	TS38A	38	25	40	452X260	1.5	400/50/3	830X470X770	112
	TS38A	38	25	40	452X260	1.5/2.2	400/50/3	830X470X770	112
	TS44A	44	30	50	500X270	1.5	230/50/3	870X520X770	116
	TS44A	44	30	50	500X270	1.5	400/50/3	870X520X770	116
	TS44A	44	30	50	500X270	1.5/2.2	400/50/3	870X520X770	116

M= Single Phase Motor, D= Two speeds , T= Three-phase Motor.